

Meeting the processing demands

# EMG Solutions for Metal Service Centres



# Our Solutions to Increase Your Production Yield

Steel, aluminium and other non-ferrous service centres are modern, high-performance processing companies with an extensive delivery and service programme of slit strips, sheets and blanks of hot-rolled and cold-rolled material, surface-finished strips and special alloys. They see themselves as a link between rolling mill operators and processing companies.

Figures from Eurometal 2017 indicated that already 45 % of the flat product material passes through metal service centres. In addition, in another report from Grandview Research<sup>1</sup> published in 2019 the global metal service centres market demand was estimated at 593,474.2 kilotons in 2018 and is anticipated to expand at a CAGR of 3.5 % from 2019 to 2025<sup>1</sup>. The relevance of this distribution channel therefore does not need to be emphasised further.

These metal service centres have to master special challenges because their most important customers, the automotive companies, are facing a paradigm shift. A decreasing share of steel in the automotive sector is expected, while at the same time the trend is towards more and more high-strength and ultra-high-strength steels with low thicknesses.

The advent of e-mobility and autonomous driving are also among the challenges. As a result, service centers must compete in the market by using the latest technologies and differentiating themselves in terms of service, quality, agility and flexibility.

In this white paper the interested reader will find an overview of the

automation solutions offered by EMG Automation GmbH with a special focus on the needs of steel and aluminium service centres and independent flat metal processors.

This includes basic strip guiding and steering control technologies for reliable operation of the various coil processing units, as well as a wide

range of product solutions for quality assurance and increasing production yield in a metal service centre (MSC).

<sup>1</sup><https://www.grandviewresearch.com/industry-analysis/-service-centers-market>

## EMG Strip Guiding



## EMG Width Measurement

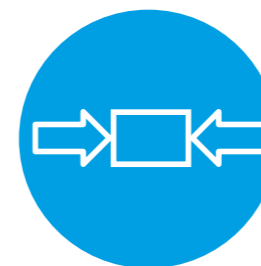

## EMG Thickness Measurement

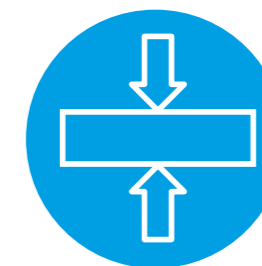

## EMG Lubrication Measurement



# Content

<b>Strip Guiding with EMG Solutions</b> .....	<b>6</b>
Higher Quality & Increased Efficiency by Reliable Strip Guidance .....	7
A Major Task: Uncoiling of Incoming Material .....	8
A Full Basket of Technologies for Strip Guiding.....	9
<b>Quality Assurance with EMG Solutions</b> .....	<b>10</b>
Transparency About Quality.....	11
<b>Strip Width Measurement with EMG BREIMO &amp; EMG iCAM®</b> .....	<b>12</b>
Increased Material Yield Based on Precise Width Measurement.....	13
EMG BREIMO: Advantages & Technical Data .....	14
Strip & Slit Strip Width Measurement with EMG iCAM®: A New Possibility .....	15
EMG iCAM®: The Solution with Extended Functionality.....	16
EMG iCAM®: Advantages & Technical Data .....	17
<b>Strip Thickness Measurement with the EMG iTiM System Family</b> .	<b>18</b>
Know the Exact Thickness of Your Incoming Material .....	19
EMG iTiM with Isotope Systems: An Established Method .....	21
EMG iTiM with Laser Solutions: The Flexible Newcomer .....	22
EMG iTiM with X-ray: For Special Cases & with Accuracy in Focus.....	24
Revamping with EMG iTiM: Cost Efficiency is Key .....	26
Revamping with EMG iTiM: Plug and Play .....	27
<b>Lubrication of Coils and Sheets EMG SOLID® IR &amp; LIF</b> .....	<b>28</b>
The Best Technology for Your Application .....	29
EMG SOLID® IR & LIF: Improved process stability and reliability.....	30
<b>EMG's Scope of Delivery</b> .....	<b>32</b>
From Components, Systems & Service to Turn-key Solutions .....	33
EMG's Service Team: We Speak Your Language .....	34
Let's Start a Project with EMG! .....	35

# Your Needs define our Focus



→ EMG's Strip Guiding Solutions assure the correct strip position

Do you need transparency about the strip & slit strip width in your process?

→ Trust in EMG BREIMO & EMG iCAM® Width Measurement Solutions

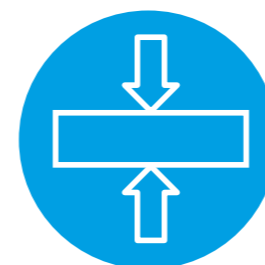
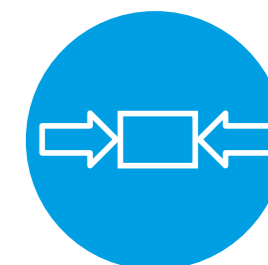

Do you need security about the strip thickness in your process?

→ Trust in the EMG iTiM Family for Online Thickness Measurement

Do you want to be sure that all material is oiled correctly and uniformly?

→ Trust in EMG SOLID® Online Oil Layer Measurement





EMG Solutions for Metal Service Centres

# Strip Guiding with EMG Solutions



Benefit from our long-term experience and wide range of solutions!

## Strip Guiding with EMG Solutions

# Higher Quality & Increased Efficiency by Reliable Strip Guidance



For decades, EMG has been the world's leading supplier to the metal industry when it comes to strip guiding and reliable strip guidance in the various process steps. Inductive and optical solutions are used in this area, as well as systems based on radar technology for strip centre or strip edge control.

For metal processing centres, EMG product solutions are essential for the controlled and trouble-free uncoiling and recoiling of high-quality strips. In addition, there is a wide variety of applications where the strip position must be reliably determined in order

to ensure trouble-free transport of the strip through the processing line. An example is the strip guiding control in front of a side trimmer, which has a direct influence on the material yield. A strip guiding system always consists of three components: the sensor technology, the intelligent control, and the actuator technology. All three elements are offered by EMG - also as turnkey projects -, supplemented by the corresponding commissioning and field services and a long-term spare parts availability. With regard to the actuator technology, EMG offers both hydraulic and electromechanical solutions.

All in all, EMG's product portfolio includes an extensive range of solutions that are used by metal service centres and independent flat material processors worldwide. In the following chapters we present the essential building blocks of these EMG product solutions to the reader, summarise the essential technical data and outline the main fields of application.

This white paper concludes with some remarks on how to optimally prepare and implement a successful project in cooperation with EMG.

### Key Challenges

The importance of strip guiding systems in service and processing centres for flat metal products lies in the fact that they are critical to the overall quality of the finished product. Proper strip guiding ensures that the strip is processed correctly, which leads to higher-quality products, fewer defects, and reduced scrap. In addition, strip guiding systems can help to reduce downtime and increase overall efficiency, which can have a positive impact on the bottom line of the service centre.

Some of the key challenges facing strip guiding systems in such centres include:

- » Maintaining the proper alignment of the strip: The strip needs to be properly aligned throughout the processing line to avoid defects and ensure that the final product meets the required specifications.

- » Ensuring uniform tension control: Strip guiding systems must help to allow uniform tension control throughout the process to prevent edge wave and other defects.
- » Coiling quality: Allowing perfect uncoiling and recoiling of the processed material for achieving the end customer specifications.
- » Coping with varying strip thicknesses and widths: The strip thickness and width can vary throughout the coil and much more important significantly after material change, which makes it difficult to maintain consistent processing and position measurement conditions.

- » Managing the production speeds involved: Strip guiding systems need to be able to operate at high speeds while still maintaining guiding accuracy and reliability. All these requirements for strip guiding systems are perfectly reflected by EMG's product portfolio.

In general, a strip guiding system always consists of a selection of 3 major components: sensors, electronics, and actuators.

Determining the strip centre or edge position – including controlling the strip position and movement – is the single most important goal for all strip guiding solutions. Based on decades of experience and around 1,500 guiding systems sold every year, EMG has developed a wide range of sophisticated optical, inductive, and radar-based sensors for achieving this goal.



# A Major Task: Uncoiling of Incoming Material

Metal service centres and processors live from precise cutting and the correct allocation of the processed material to the right customer orders in line with their requirements. In the context of this, two processing steps occur again and again. First, the material delivered as coils must be uncoiled so that it can be transferred to the various further processing and cutting or slitting processes. Uncoiling is therefore necessary in 100 % of the cases. If the processed strip material is then delivered again in coil form, it must logically also be recoiled again. Also in these cases, strip guiding is essential to achieve the required coiling quality.

Using the example of uncoiling, a typical strip guiding system as used today in hundreds of metal service centres and processors is explained in more detail below.

A strip guiding control on the uncoiler is used to feed the decoiled strip into a production line or machine with edge or centre guiding. It is necessary when individual windings protrude from the delivered material coils, when the winding condition is generally unsatisfactory and to compensate the strip camber. Another reason for an automatic strip position guiding is given when the coils are not exactly centred on the coiler mandrel.

## Implementation

Normally a continuous electro-hydraulic control circuit is used for strip guiding control. Alternatively, an electric servo cylinder (EMG ESZ) can also be used for low masses to be moved. The deviation of the strip position from the nominal position is determined by an optical HF alternating light measuring device – either so called EVK (sensor positioner edge) or EVM (sensor positioner centre). Due to the large distance to the strip, inductive or capacitive solutions are ruled out in an arrangement as shown in figure 1. The electronic strip guiding controller EMG iCON® reads in the edge values of the strip position measurement. The power amplifier of the strip guiding controller then continuously steers the servo valve in the hydraulic control circuit (or the electro servo cylinder) so that the unwound strip is held in the preselected position. Depending on the line process, the unwinding can be carried out either as strip centre or strip edge control.

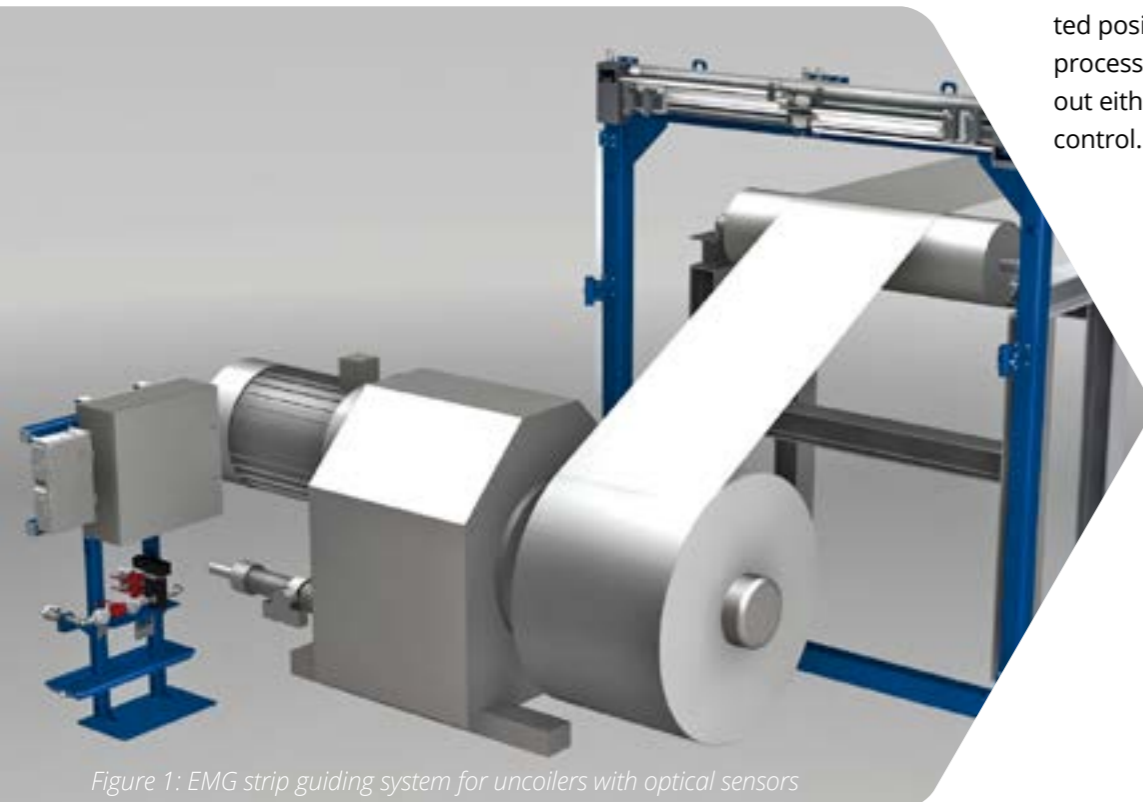

Figure 1: EMG strip guiding system for uncoilers with optical sensors



# A Full Basket of Technologies for Strip Guiding

The essential components are:

- » EVK - sensor positioner edge or
- » EVM - sensor positioner centre or
- » SMI - inductive strip measuring sensor (only for installations behind the deflector roll and centre control),
- » EMG iCON® as intelligent digital control system,
- » EMG servo valves (single-stage or two-stage) as part of a hydraulic system or
- » Electric servo cylinder ESZ

As mentioned before EMG provides a wide range of strip guiding technologies for every step in the processing of strips at metal processing centres and processors. A snapshot of this technology portfolio is shown in figure 2.

On the sensor side, this means a corresponding selection of optical and inductive sensor solutions in different classes of accuracy, which make it possible to achieve correct strip guidance at every stage of the process. On the electronics and software side, EMG supplies both the digital controller (EMG iCON®) and the automation software as well as the necessary industrial PCs and visualisation units.

On the actuator side, the customer has the choice between classic hydraulic solutions using the EMG servo valve or the electric servo cylinders (EMG ESZ), which can be used to replace complex hydraulic solutions. You can find out more about these solutions in the brochure available here: [Strip Guiding Systems Sensors](#).



Figure 2: EMG strip guiding components and solutions (clockwise: EMG ESZ, EMG SMI inductive sensor, EMG hydraulic stand with EMG servo valve, EMG iCON® electronics, EMG steering frame, EMG EVK optical sensor)

EMG-Lösungen für Metall-Service-Center

## Quality Assurance with EMG Solutions

Quality Assurance with EMG Solutions

## Transparency About Quality

The basic quality requirements of a metal processing centre refer firstly to the dimensional measurement of the strip, be it the strip thickness, the strip width as well as the corresponding properties of slit strip in the form of slit strips in different widths.

And secondly defined material properties play a major role. At this point, especially the surface characteristics of the strips to be processed are of

interest. While material properties such as roughness or strength values are less frequently requested here, the importance of correct and uniform oiling, which is a basic prerequisite for the various further processing steps, is often in the foreground.

In the following sections we will therefore focus on width and thickness measurement as well as oil layer determination.

In addition, with the optical online roughness measuring system EMG SORM® and the magnetic inductive system EMG IMPOC, EMG offers proven and reliable solutions for roughness measurement on a wide range of surfaces and for the measurement of the material properties tensile strength and yield strength in ferromagnetic steel for the most demanding quality requirements in MSC.



Figure 3: EMG QA systems from left to right; EMG iTIM, EMG iCAM®, EMG BREIMO, EMG SOLID®, EMG SORM®, EMG IMPOC

[back to content](#)

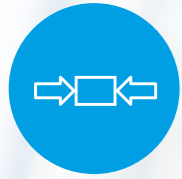

EMG Solutions for Metal Service Centres

## Strip Width Measurement with EMG BREIMO & EMG iCAM®

Do you need transparency about the strip & slit strip width in your process?

➔ Trust in EMG BREIMO & EMG iCAM®  
Width Measurement Solutions

Strip Width Measurement with EMG BREIMO & EMG iCAM®

## Increased Material Yield Based on Precise Width Measurement

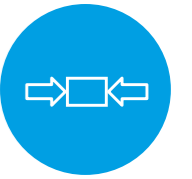

There are many reasons why strip width measurement in flat metals production and processing is important. In general, after the melting process steel and aluminium products are usually shaped in the hot rolling mill and then in the cold rolling processes as coils several hundred meters long and in different width and thickness classes.

The strip width and thickness must be accurately monitored as the dimensions are important features to fulfil the customer orders. One main topic with respect to metal service centres and metal processors is the material yield.

The more precisely the width can be determined for the cutting process, trimming and slitting, the more material can be used and delivered to the end customer.

### Strip Width Measurement with EMG BREIMO: Well Known World-wide

Terms like resilience, robustness, reliability and proven, worldwide use come into the mind if you think about the electro-optical strip width measurement system EMG BREIMO.

BREIMO is EMG's contact-free, optical strip width measuring system for continuously running production processes in the cold rolling, finishing, and processing area. Consisting of a measuring frame with two so called sensor positioning devices EVK, the

corresponding light sources and a common linear stroke transducer.

#### Functional principle:

The strip edge is detected by the movable sensor positioning device (also called receiver adjustment device), which is equipped with high-frequency (HF) alternating light measuring devices of type LS 13/14 that are protected against ambient light.

If a lateral displacement of the strip edge occurs due to changes in width or due to the strip horizontal movement, this displacement is detected by photoelectric sensors. The DC motor for moving the LS 13/14 photoelectric sensors (i.e., following the position of the strip edge) is then controlled by the master control electronics. This is done until the strip edge covers exactly half of the photoelectric sensor measuring spot (intensity control).

#### Special features

By using high frequency alternating light transmitters, the systems are insensitive to ambient light influences, whether from artificial (e.g. moving light sources on the crane) or natural light sources (e.g. sunlight through the hall skylight). In addition, the reference measuring principle is used to compensate for soiling of the light sources.

While the measuring receiver detects the lateral position of the strip edge, the reference receiver measures the basic brightness of the light spot, since there is no interference of the optical path between it and the light spot. If the light intensity falls below an adjustable level, a message is sent to the production line and a cleaning process or other maintenance can be initiated.

With this principle, one measuring and one reference receiver are aligned to the same light spot of the light source (LLS) in each measuring device.

With several hundred systems installed and delivered worldwide, EMG BREIMO can truly be described as the

workhorse of width measurement systems in the metal industry.

By investing in EMG BREIMO, the user is relying on a proven, robust, easy-to-maintain system with manageable complexity and high accuracy. The expectations placed in workhorse is fulfilled in every respect.

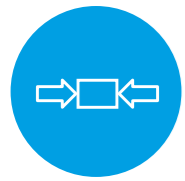

Strip Width Measurement with EMG BREIMO & EMG iCAM®

## EMG BREIMO: Advantages & Technical Data

The table below summarises the advantages but also the limitations of the EMG BREIMO width measurement solution and selected technical data.

EMG BREIMO advantages	Limitations
Industrial proven, robust technology	Measurement of max. two strip edges
Automatic compensation of debris on optical paths (warning if cleaning is required)	
No sensitivity to external light sources	
Very large measuring distances possible	
Low maintenance, limited complexity	

EMG BREIMO selected technical data		
Strip width range	400 – 3,000 mm	
Measuring gap	Up to 2,000 mm	
Measuring frequency	Up to 100 Hz	
	BREIMO	BREIMO-H
Measuring accuracy	± 0.5 mm	± 0.2 mm
Max. pass line fluctuation	≤ 20 mm	≤ 10 mm
Distance pass line to sensor	< 1.5 m	< 1.0 m

Table 1: Overview EMG BREIMO features and technical data



Figure 4: EMG BREIMO upper part - high precision version

Strip Width Measurement with EMG BREIMO & EMG iCAM®

## Strip & Slit Strip Width Measurement with EMG iCAM®: A New Possibility

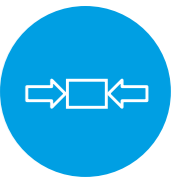

As is well known, taste often comes with the meal and the demands on quality are continuously increasing. In a figurative sense, this also applies to strip width measurement in the metal industry, where users in an increasing number of cases request additional features for a width measurement system.

In the case of metal service centres and mill operators, strips are also often slit longitudinally into a customer-specific number of slit strips in order to provide the end customer with an optimum and immediate product for use in their production processes.

The EMG iCAM® intelligent width measurement system is the perfect answer to these requirements.

EMG iCAM® fulfils all basic requirements for a widely applicable intelligent width measurement system. Key features include:

- » A scalable width range for strip widths of 10 to 2950 mm.
- » The possibility to measure the width of slit strips in a range of typically 10 to 500 mm for each individual slit strip.
- » Width measurement of the entire coil length with high accuracy of +/- 0.05 mm (2σ).

- » All data are available in real time for the line control systems and can be stored for further analysis (quality and trends) and can be provided for the customers quality assurance databases.
- » The measuring does not interfere with the production process. It is robust and reliable enough to work uninterruptedly in long time intervals in a hard industrial environment.

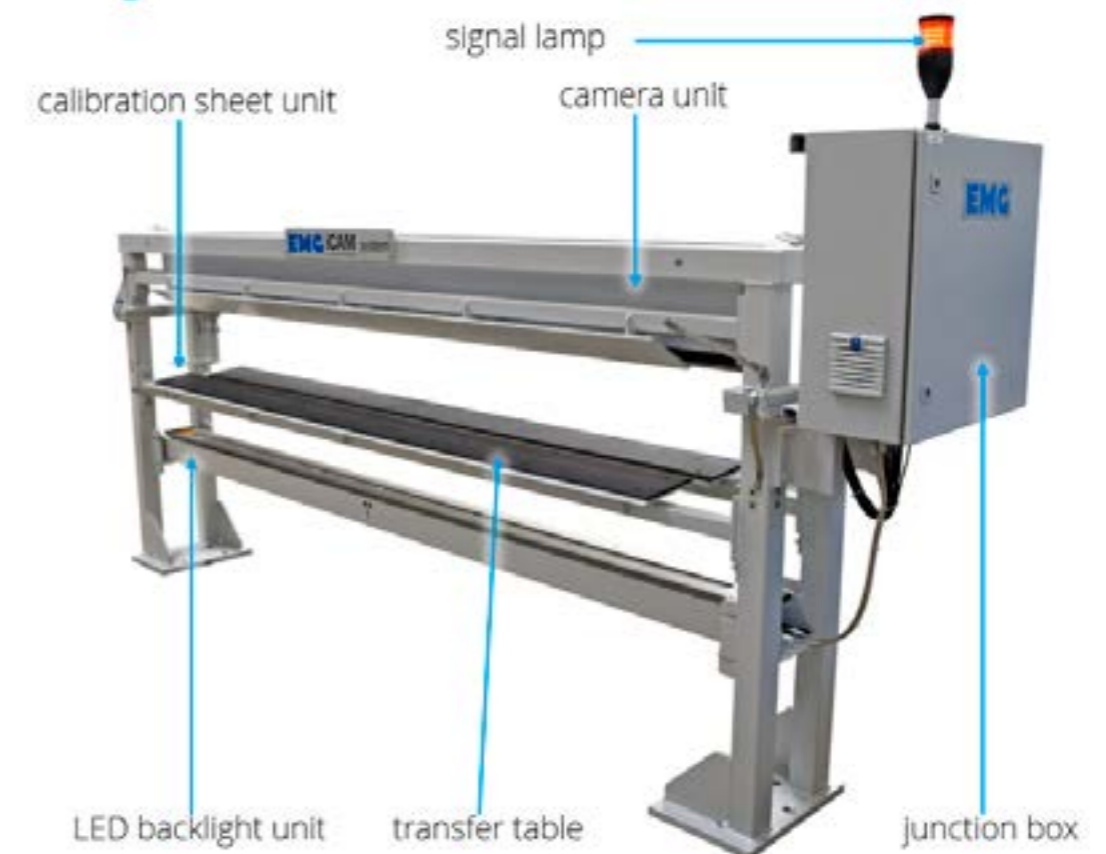
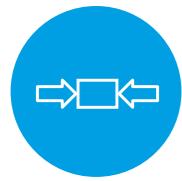

Figure 5: EMG iCAM® measuring system - cameras in the upper part, light sources (backlight unit) in the lower part





Strip Width Measurement with EMG BREIMO & EMG iCAM®

# EMG iCAM®: The Solution with Extended Functionality

Two core components distinguish the system from the classic EMG width measurement BREIMO (see before). This is on the one hand, the multi-camera detection unit and on the other hand the light source – an infrared backlight unit – for the illumination of the whole strip width.

The multi-camera detection unit includes a scalable number of camera arrays for the detection of light leaked by material edges. The arrangement of the camera arrays depends on the customer application.

The camera arrays include CMOS chips for the light detection and FPGA chips for the image data pre-processing. Furthermore, the cameras include application specific lenses. The typical distance between the multi-camera detection unit and the strip is about 200 to 300 mm.

The backlight unit is mounted below the strip material and includes several LED module units. The LED module units have a standardised length of 260 mm and are connected to realise the measurement over the maximum material width. The LED module units are optimised to the IR wavelength range of 850 nm to minimise the influence of extraneous light sources. The typical distance between the emitter unit and the strip material is between 150 to 200 mm.

The multi-camera detection unit and backlight unit can be mounted on a standard frame, a customised frame or without a frame for space-critical line layouts.

The measurement accuracy depends, among other things, on the stable and optimised passline range. A variation of the strip passline within the detec-

tion range of 19 mm including strip thickness, strip waves, and strip edge ripples can be compensated. Variations outside this passline range have a negative influence of the measurement accuracy or the measurement is impossible. Stabilisation rollers can be used to optimise the passline.

Furthermore, the MSA procedure, study-type 1, is offered for the product solution EMG iCAM®.

The cameras are arranged in such a way that the image recording area of 2 cameras overlaps on the material. As the light detection of each position on the strip is performed by two adjacent cameras, the image analysis takes advantage of the stereoscopic effect. In addition, the image information from the two adjacent cameras is directional and provides additional information.

In summary, it can be stated that EMG iCAM® fully meets the extended user requirements for an intelligent width measurement system and offers additional value for the production and further processing of metallic strips.

This concerns the possibility to also measure slit strips after the slitting process in a wide width range with high precision.

In this respect, extended functionality, flexibility, and intelligence are the distinguishing features of the younger sister of the EMG BREIMO width measurement system. In close dialogue with EMG, the end user always chooses the right solution based on his specific requirements.

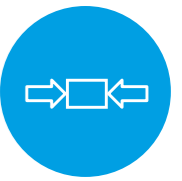
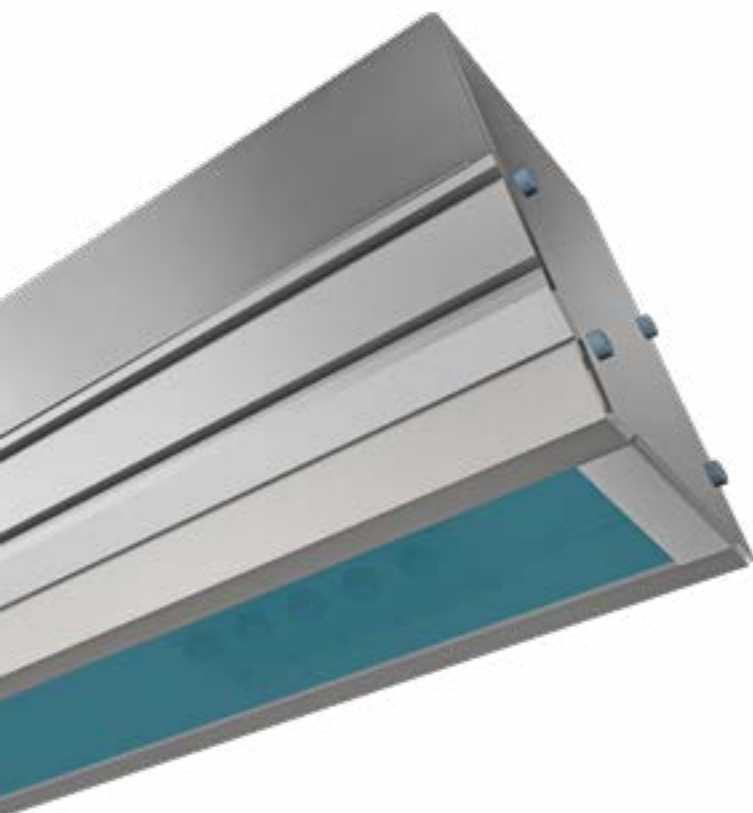

Strip Width Measurement with EMG BREIMO & EMG iCAM®

# EMG iCAM®: Advantages & Technical Data

Table 2 gives a summary of the advantages and limitations as well as selected technical data of EMG iCAM®.

EMG iCAM® advantages	Limitations
No sensitivity to external light sources	Limited measuring gap
Width measurement of slit strip/s	
No moveable mechanical elements	
Fully software driven image analysis	
Number of cameras scalable depending on the width spectrum of the production line	

EMG iCAM® selected technical data	
Strip width range	up to 2,950 mm
Gap between sender and receiver	Typically 500 mm
LED IR wavelength	850 nm
Measuring accuracy	up to ± 0.05 mm (2σ)
Passline detection range	19 mm

Table 2: Overview EMG iCAM® features and technical data



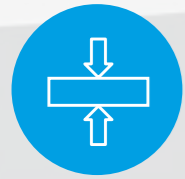

EMG Solutions for Metal Service Centres

## Strip Thickness Measurement with the EMG iTiM System Family



Do you need security about the strip thickness in your process?

➔ Trust in the EMG iTiM Family for Online Thickness Measurement



Strip Thickness Measurement with the EMG iTiM System Family

## Know the Exact Thickness of Your Incoming Material

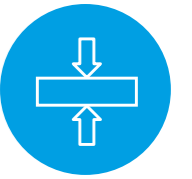

There are many reasons why thickness in flat metals production is important. All materials have a certain tolerance in production; materials produced too thin or too thick can cause problems further down the production chain and finally at the end customer's site. This applies for nearly all production steps beginning in the hot mill down to the finishing and processing lines at the metal producers and in service centres. For metal service centres and processors, knowing the exact thickness of the incoming material is key for the material allocation to different end custo-

mers and for the internal processing and machinery usage.

The thickness measuring systems employed in the metal industry today are primarily based on three different technological approaches: X-ray measurement, isotope measurement methods and optical measurement methods based on confocal optics and/or laser technology.

Each technology has its own specific advantages and disadvantages, and ultimately the application determines the selection or even the most appro-

priate combination of measurement methods. Such systems must function reliably under all plant conditions in very rough, tight installation locations, for a wide range of alloys and thickness values and partly with very high sampling times for control tasks.

The expansion of EMG's product portfolio to all the thickness measurement methods currently used in industry (X-ray, isotopes, laser), and the associated design and software know-how, opens completely new opportunities for the user, also for modernisations and revamps.

perfecting your performance

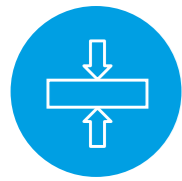

Strip Thickness Measurement with the EMG iTiM System Family

# EMG iTiM with Isotope Systems: An Established Method

Isotope radiation-based thickness measurement systems offer several advantages for the application in metal service centres:

- » **High accuracy:** Isotope radiation-based systems can provide highly accurate thickness measurements, with accuracy typically within 0.1 % of the actual thickness.
- » **Wide range of thicknesses:** Isotope radiation-based systems can measure a wide range of thicknesses, typically from less than 1 mm to over 100 mm, which makes them suitable for measuring a variety of products.
- » **Robustness:** Isotope radiation-based systems are designed to withstand harsh industrial environ-

ments, which makes them suitable for use in metal service centres.

- » **Minimal maintenance:** Isotope radiation-based systems typically require minimal maintenance, which reduces operational costs and downtime.

EMG isotope radiation-based measuring systems (EMG iTiM iso) work with different isotopes depending on the area of application and can be used in both hot and cold areas.

In the set-up of such a system, the isotope source and detector are on opposite sides of the material to be measured. As shown in Figure 6 the isotope emits a constant gamma

radiation, which is limited to a constant form due to the built-in collimator. The part of the radiation that is not absorbed or scattered in the material to be measured enters the detector. The ionisation of the gas in the ionisation chamber generates electrons which are dissipated by means of applied high voltage and processed as a measuring signal.

After amplification of the measuring signal, the correct measured value is calculated on base of the potash brier curve. For the determination of the absolute thickness value, additional factors for alloy compensation need to be considered.

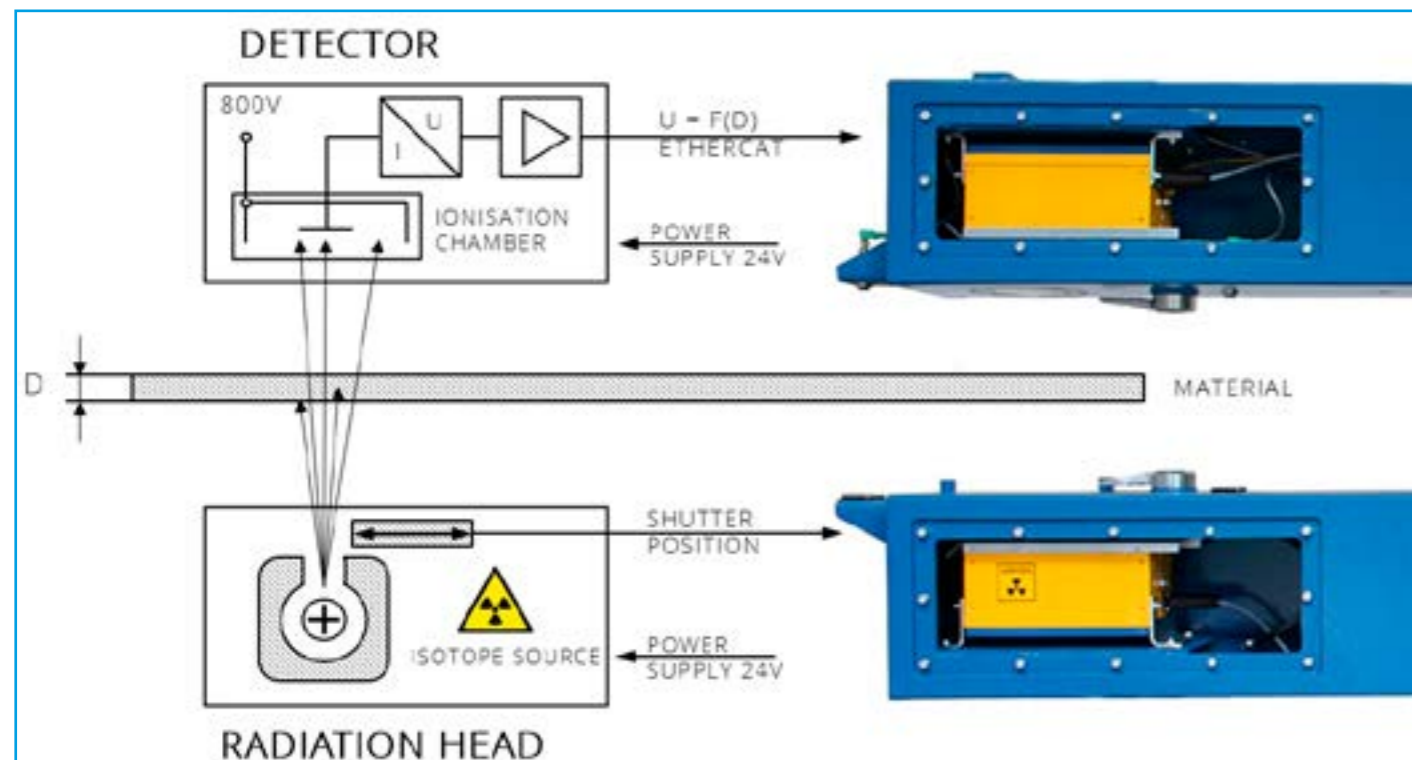

Figure 6: Set-up principle of an EMG iTiM iso

In Table 3 the advantages and limitations of thickness measurement with ionising radiation are summarised as well as some technical data of EMG iTiM iso.

Advantages of ionising radiation	Limitations
No temperature influence	Limited availability of isotope sources
No influence of surface dust, fog, vibration	Low spatial resolution
Industrial proven technology	Alloy compensation required
	Country specific installation and import requirements for isotope sources
	Country specific handling license for isotopes

Basic technical data EMG iTiM iso	For isotope Am 241*
Thickness range	0.2 – 7 mm
Measuring gap	Up to 400 mm
Accuracy (according to IEC 61336)	± 0.1 % of measurement value, not better than 0.5 µm
Integration time	≥ 10 ms (selectable)

Table 3: Overview EMG iTiM iso features and technical data

\*Others on request

With respect to isotope-based measurement techniques, it can be summarised that this is a long-established method in the industrial sector, which is used at many sites worldwide.

However, the major drawback is the increasing limitation in the availability of suitable isotope sources. In this respect, isotope measurement

methods should be avoided as far as possible in new investments and existing isotope sources should be used in existing facilities as long as possible. Fortunately, the modular design of EMG thickness measurement solutions ensures that existing isotope sources, after prior testing by EMG, can often be reused for revamps and modernisations.

Overall, isotope radiation-based thickness measurement systems offer high accuracy and reliability, making them a suitable choice for metal service centres that require precise and continuous thickness measurement. Isotope radiation-based systems have to be compliant with relevant safety regulations, including those related to radiation exposure and environmental protection.

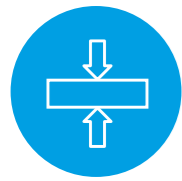

## Strip Thickness Measurement with the EMG iTiM System Family

# EMG iTiM with Laser Solutions: The Flexible Newcomer

EMG's laser-optical systems are characterised by low complexity, reasonable space requirements, and flexible integration into the production line. The areas of application in steel, aluminium and other non-ferrous metal service centres and at metal processors are as diverse as they are different.

Based on the principle of laser distance or difference measurement, mainly triangulation sensors are used. Depending on the application, confocal monochromatic sensors can also be used for even higher system accuracies. Due to the complexity and sensitivity of the latter technology, we focus on triangulation sensors in this white paper.

Thanks to their compact design, the measuring systems can be easily integrated even in confined installation spaces and process lines.

Various arguments favour the use of such systems in metal service centres:

- » **Accurate measurements:** Laser-based triangulation systems provide highly accurate measurements with precision up to the micrometre level.
- » **Speed and efficiency:** Laser-based triangulation systems can measure thickness quickly and efficiently, allowing metal service centres to process large quantities of material in a short amount of time.
- » **Versatility:** Laser-based triangulation systems can be used to measure the thickness of a wide

variety of metal products, including flat sheets, coils, and plates.

This makes them a versatile tool for steel / aluminium / non-ferrous metal service centres and processors.

- » **Robustness:** The measurement isn't influenced by the chemical composition of different steel grades and alloys.
- » **Cost-effective:** While laser-based triangulation systems can still be a significant investment, they are in general less costly and easy to integrate into new and running production lines, following a modular system. Furthermore, there are no special certificates required compared to the work radioactive sources or X-ray systems, which reduces the total cost of ownership dramatically.

» In Figure 7 the set-up principle of a laser triangulation measurement is shown. Two opposing laser distance sensors project a laser spot onto the material. Here a wide beam spot is used to average the effect of microscopic surface roughness. The scattered laser lights spot falls on a RS-CMOS sensor at a certain angle, depending on the distance. The material thickness is calculated from the total distance of the two sensors to each other and the difference of the measured individual distances to the material.

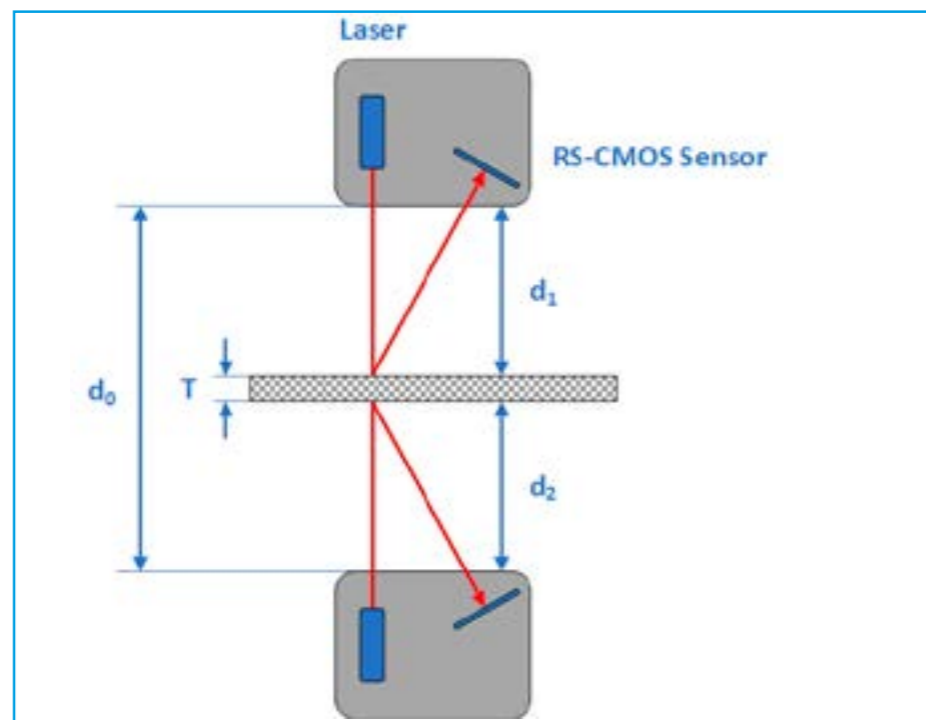

Figure 7: Set-up principle of a triangulation measurement with laser diodes.

$$T = d_0 - d_1 - d_2$$

In Table 4 we summarise the advantages and limitations of thickness measurement with laser-based triangulation measurement as well as some technical data of EMG iTiM laser system.

Overall, laser-based triangulation thickness measurement systems offer a range of benefits for metal service centres and metal processors, including accuracy, speed,

efficiency, versatility, and cost-effectiveness.

Advantages of laser-based triangulation	Limitations
No cooling required	Sensitive to steam, dust, vibrations
No alloy compensation required	Certain sensitivity to surface structures
High spatial resolution	C-frame gap 100 – 280 mm to be considered
High range of gauges	Not suited for rolling applications
No special certificates or handling license for import required	

Basic technical data EMG iTiM laser	
Thickness range	0.05– 20 mm
Measuring gap	100 – 300 mm
Accuracy (according to IEC 61336)	± 5 µm (for measuring field depth of 20 mm)
Integration time	0.2 to 8 ms

Table 4: Overview EMG iTiM laser features and technical data



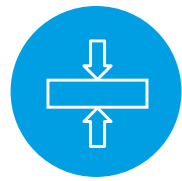

# EMG iTiM with X-ray: For Special Cases & with Accuracy in Focus

The highest measuring accuracy and reliability is provided by the X-ray transmission measuring method.

The X-ray source and detector are arranged on opposite sides of the material to be measured. The non-absorbed part of the X-ray radiation

provides the basis for a highly precise thickness measurement, where material-related influences are compensated by the software.

The EMG iTiM xray measuring system has been developed to ensure protection of the entire system even

when used under the most difficult conditions in hot and cold rolling applications. For metal service centres this latter point is less important.

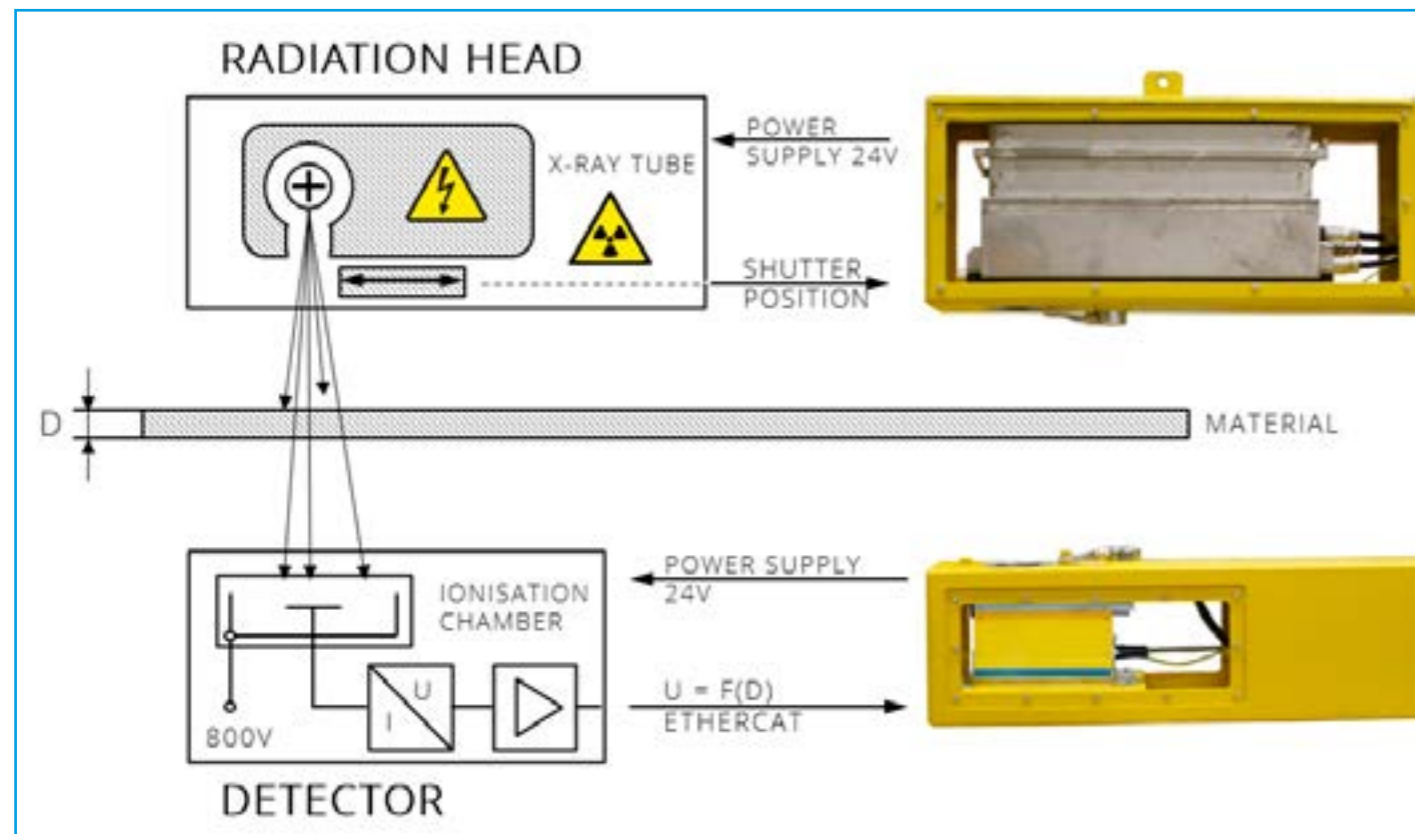

Figure 8: Set-up principle of EMG iTiM xray

In table 5 the advantages and limitations of thickness measurement with X-ray radiation are summarised as well as some technical data of EMG iTiM xray system type.

With respect to X-ray-based measurement techniques, it can be summarised that this method is well established in the hot and cold mill sector.

The X-ray measuring devices can be used over a wide thickness range due to different generator voltages and deliver highly accurate measurement results.

For metal service centres EMG iTiM xray is only used when high accuracy is required, or isotope-based systems are not available or should be avoided.

Overall, while X-ray strip thickness measurement systems have advantages in terms of accuracy, they may be less practical and cost-effective for some service centres compared to laser or isotope-based systems.

Advantages of X-ray radiation	Limitations
No temperature influence	Handling of X-ray sources requires official approvals
No influence of surface, dust, steam, vibration	Country specific installation and import requirements for X-ray sources
Low pass-line influence	Alloy compensation required
Medium spatial resolution	Higher thickness values require higher X-ray generator voltages
Very robust and stable systems	
High radiation safety (can be shuttered or switched-off)	
Basic technical data EMG iTiM xray	
Thickness range	0.002 – 60.00 mm
Measuring gap	Up to 2000 mm
Accuracy (according to IEC 61336)	± 0.1 % of actual value
Integration time	≥ 1 ms (selectable)

Table 5: Overview EMG iTiM xray features and technical data



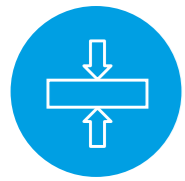

Strip Thickness Measurement with the EMG iTiM System Family

## Revamping with EMG iTiM: Cost Efficiency is Key

Today, metal service centres and metal processors must respond to increasing competitive pressure, which means that efficiency must be increased in all areas of the company.

Particularly in case of thickness measurement systems such as those of the EMG iTiM product family, the question very often arises during modernisation to what extent the reuse of modules and the use of existing design solutions is possible. In this respect, the partial reuse of components and integration solutions results in significant cost advantages for modernisations. Existing measuring systems can be adapted to modern standards through extensions or conversions.

Economic efficiency takes the key role in this decision. Often, the existing electrotechnical equipment, such as the automation and drive technology, no longer meets the required safety standard and the state of the art. In addition, the availability of isotope sources over longer periods of time is not assured, and new purchases of the radioactive sources used in thickness measurement are no longer possible. The same applies to the procurement of spare parts for thickness measurement systems, which are no longer offered by the original manufacturers. However, it may also be that the operator know-how for the old systems is only limited or no longer available.

Roughly classified, the following options and their combination are on the EMG iTiM delivery programme for modernisations:

- » Replacement of the control cabinet, the analysis software, and necessary adaptations of interfaces.
- » Replacement of the radiation sources and/or detectors – e.g., renewal of the X-ray generator and the X-ray detection unit – or, in the case of isotope sources, after examination by EMG, their further utilisation, if possible.
- » New C-frames or replacement of other construction elements such as brackets and guides.

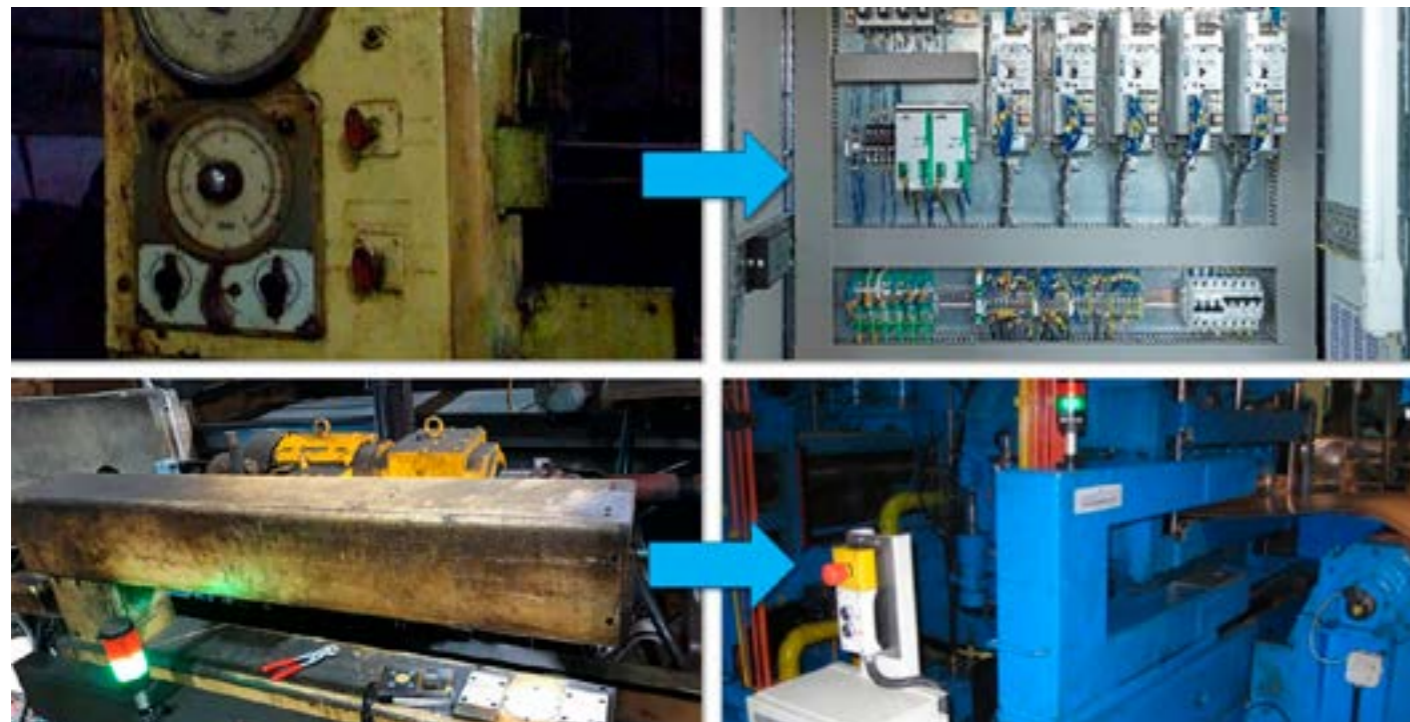
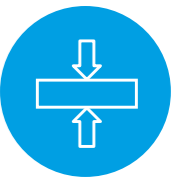

Figure 9: Turning old into new with EMG iTiM

Strip Thickness Measurement with the EMG iTiM System Family

## Revamping with EMG iTiM: Plug and Play



The savings when retrofitting an existing installation can be more than 70 % compared to a new purchase (incl. all associated planning, purchasing and project costs).

This is partly due to the modularity of the EMG iTiM system components, especially with regard to the sensor and detector technology, and the high flexibility in the design.

The flexibility of the EMG iTiM solutions is reflected by the various design concepts shown in Figure 10 below.



Figure 10: Plenty design concepts for EMG iTiM modernisation projects

### Easy revamping with plug and play

In contrast to the measuring equipment in new plants, the modernisation of existing production lines is much more complex. Due to the modularisation of the EMG iTiM solutions and a special design of the mechanics, these systems are ideally suited for such revamps. The replacement of these old systems can be accomplished within a few hours in one or two shifts.

In any case, the new components and system parts are delivered to the end user fully wired and tested.

The plug and play capability of the EMG iTiM systems also makes it possible to ship them in a fully assembled state. This often eliminates time-consuming assembly processes when installing the system in the plant.

The plug and play approach is particularly advantageous for the installation of thickness measurement systems in existing lines without existing measurement systems and with short installation timescales.

Due to the many years of experience of EMG's "Thickness Measurement Team" with all process steps of flat strip production and especially the needs of metal service centres, EMG can develop a modernisation concept tailored to your application at any time. Since EMG supports the user and customer in all questions of modernisation from start to finish – from conceptual design, engineering and delivery to installation and assembly – if desired also as a key-turn project, the customer takes neither economic nor technical risks.



EMG Solutions for Metal Service Centres

# Lubrication of Coils and Sheets EMG SOLID® IR & LIF



Do you want to be sure that all material is oiled correctly and evenly?

➔ Trust in EMG SOLID® Online Oil Layer Measurement

Lubrication of Coils and Sheets EMG SOLID® IR & LIF

## The Best Technology for Your Application



The EMG SOLID® technology covers a wide range of applications in online oil layer measurement in the metal industry. Depending on the application requirements, either infrared technology or laser-induced fluorescence technology is used. On request, EMG can supply a complete solution including additional units, such as C-frames or homogenising rolls, including the design integration into the production plant and the associated commissioning services.

There are several important aspects to online oil layer measurement in metal service centres and flat metal processing:

- » **Quality control:** Online oil layer measurement helps ensure consistent oiling of steel, aluminium and copper coils, which is critical for achieving consistent quality in downstream processing and end products.
- » **Cost savings:** Accurately measuring the oil layer can help optimise the amount of oil used, reducing waste

and costs associated with over-oiling or under-oiling coils.

- » **Efficiency:** By measuring the oil layer online, service centres can quickly and easily adjust oiling systems to maintain optimal levels, without the need for time-consuming manual measurements.
- » **Safety:** Over-oiling can create a slippery surface that can be hazardous for workers handling the coils, so accurate measurement and control of the oil layer can help reduce safety risks, e.g., due to oil residues on the shop floor or machinery parts.
- » **Environmental compliance:** Overuse of oil can also have negative environmental impacts, so precise measurement and control can help service centres stay within regulatory limits for oil usage.

When it comes to oil layer measurement, EMG is also able to offer technological openness. Two technological approaches are part of the

EMG portfolio: infrared spectroscopy with EMG SOLID® IR and laser-induced fluorescence spectroscopy with EMG SOLID® LIF.

Both technologies have great advantages, but also some limitations in certain fields, so that the technology that promises the best measurement results in the respective application will be used in each specific case.

From today's point of view and based on experience to date, this is the widely established industrial infrared measurement technology EMG SOLID® IR in about two thirds of the cases (in particular due to the effects of oil mixtures) and, in the remaining cases, the laser fluorescence technology.

In Table 6 the main criteria for the selection of the underlying measuring principle are summarised.

		Usable Solutions EMG SOLID® IR	EMG SOLID® LIF
Installation situation	Homogenisations rolls exist or can be installed		
	Not enough space for homogenisation rolls		
Needed measuring range	< 0.1 - 6 g/m <sup>2</sup>		
	< 0.1 - 6 g/m <sup>2</sup>		
Used lubricants	Oils with similar fluorescence characteristics		
	Oils with different fluorescence characteristics and no oil mixtures		
	Oils with different fluorescence characteristics and oil mixtures		
Material surface	Shiny / strongly reflecting (e.g. bright-annealed stainless)		

Table 6: Selection criteria for EMG SOLID® IR or alternatively EMG SOLID® LIF systems

[back to content](#)



Lubrication of Coils and Sheets EMG SOLID® IR & LIF

# EMG SOLID® IR & LIF: Improved process stability and reliability

Independent of the selected measurement technology EMG SOLID® delivers a complete view of the lubrication situation over coil length and width.

are shown in red colour whereas dry areas or underoiled areas are highlighted in blue for both sides of the coil. In addition, the development of the absolute value of the oil layer in g/m<sup>2</sup> over coil length is shown below the coil map.

On the left side the absolute values for the top and bottom side of the coil at the actual sensor position are displayed.

Figure 11 shows the online visualisation of EMG SOLID®. Overoiled zones

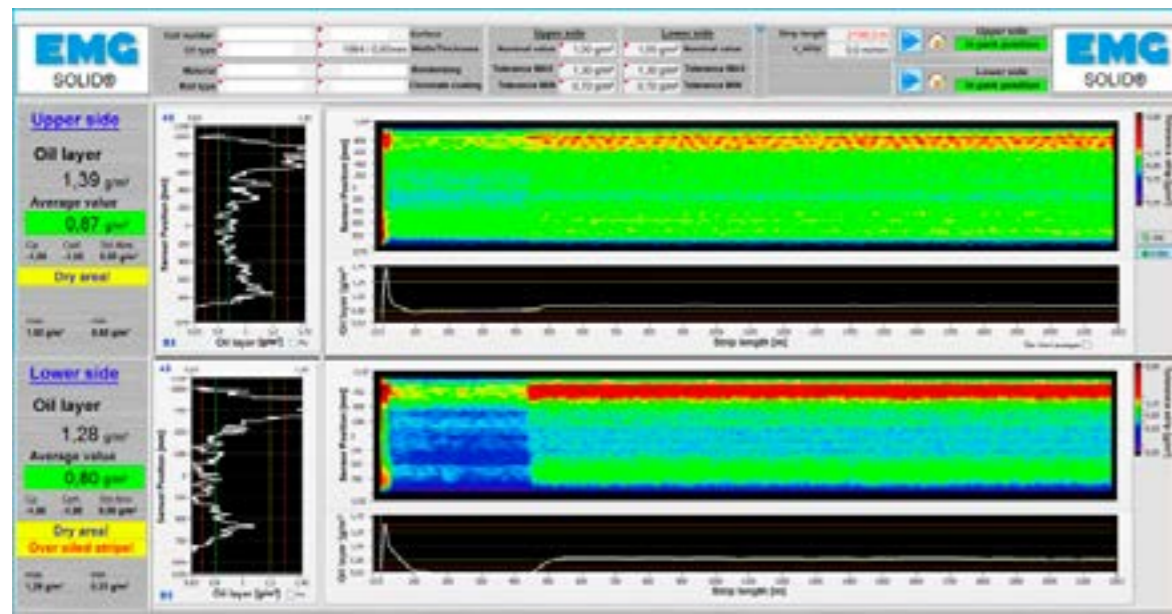

Figure 11: Coil map with lubrication profile and overoiled and dry zones



Figure 12: Measuring O-frame - equipped with a double-sided laser fluorescence sensor EMG SOLID® LIF

A typical measurement frame design is shown in Figure 12. In this case, the holder for the measuring heads is equipped with two EMG SOLID® LIF sensors for the top and bottom side of the strip. With EMG SOLID® IR infrared technology, it is necessary to homogenise the oil film before measurement. This can be done with homogenisation rollers from EMG or with homogenisation rollers provided by the customer. These rollers cannot be dispensed with for physical reasons, as the infrared measurement reacts to droplet formation on the surface and would therefore falsify the measurement result. The homogenisation rollers ensure a homogeneous lubricating film, and the measurement can be carried out reliably.

The EMG SOLID® technology covers a wide range of applications in online oil layer measurement in the metal industry. Depending on the application requirements, either infrared technology or laser-induced fluorescence technology is used.

On request, EMG can supply a complete solution including additional units, such as C-frames or homogenising rolls, including the design integration into the production plant and the associated commissioning services.

This makes EMG the preferred supplier for online oil layer measuring systems today.

Key features and data	EMG SOLID® IR	EMG SOLID® LIF
Measuring range	0.1 – 6 g/m <sup>2</sup>	0 – 6 g/m <sup>2</sup>
Measuring accuracy	Measuring range 0.1 – 0.5 g/m <sup>2</sup> : ± 0.1 g/m <sup>2</sup> Measuring range 0.5 – 2.0 g/m <sup>2</sup> : ± 0.2 g/m <sup>2</sup> Measuring range > 2 g/m <sup>2</sup> : ± 10 % from measured value	± 10 % of upper measuring range value (e.g. measuring range: 0.5 - 2 g/m <sup>2</sup> : ± 0.2 g/m <sup>2</sup> )
Materials	All metal and non-metal surfaces with low glossy level, e.g.: » Steel – cold-rolled strip, hot-dip galvanized, electro galvanized, phosphated, aluminised, ZnMg surfaces, galvanized, electrical strip » Aluminium – uncoated, pre-treated	All metal and non-metal surfaces, e.g.: » Steel – cold-rolled strip, hot-dip galvanized, electro galvanized, phosphated, aluminised, ZnMg surfaces, galvanized, electrical strip » Aluminium – uncoated, pre-treated
Lubricant types	Mineral oil, mineral oil thixotropic, hotmelts, waxes	Mineral oil, mineral oil thixotropic, waxes, hotmelts, rolling and skin pass agents, cooling lubricants, emulsions
Other coating materials		Passivations, anti-corrosive agents, anti-fingerprint coatings, cleaning agents, solvents, transparent lacquers, polymers, primers, adhesives; insulation coatings for electrical
Working distance (measuring position)	120 mm (traversing)	40 mm (traversing)
Strip height fluctuations	+/- 10 mm	+/- 20 mm
Measuring frequency	60 Hz	10 kHz
Special requirements	Homogenisation rolls in front of the measurement frame	Not suited for oils with different fluorescence characteristics and oil mixtures

Table 7: Key features and technical data for EMG SOLID® IR and EMG SOLID® LIF



EMG Solutions for Metal Service Centres  
EMG's Scope of Delivery



EMG Solutions for Metal Service Centres

## From Components, Systems & Service to Turn-key Solutions



Figure 13: Everything you can get, and you may expect from EMG

EMG's scope of delivery includes not only the technical solutions, components, and systems, but also the required service and consultancy.

The EMG service team with deep knowledge in strip guiding and quality assurance solutions provides customers in flat metals production and processing with a broad range of benefits. With our global presence, spare parts delivery, and consultancy services, the EMG team can offer specialised expertise in revamps and modernisations, as well as turn-key projects that help companies to improve their processes and increase their profitability.

The technical expertise of the EMG team in strip guiding and quality assurance solutions enables us to provide effective solutions to issues of con-

cern in the production process and processing of coils. By partnering with local representatives and subsidiaries, the EMG team can offer customised solutions that take into account local conditions, integration challenges and requirements.

Moreover, the EMG team's experience in revamps and modernisations can help companies upgrade their equipment and processes to meet changing market demands, quality goals and regulations (e.g. , in respect to ionising radiation). This can lead to improved efficiency, reduced downtime, and increased product quality.

Additionally, with turn-key projects, the EMG team can take full responsibility for the entire project, from concept to completion, ensuring seamless and successful implementation.

In summary, as shown in Figure 13 above with its in-depth knowledge of strip guiding and quality assurance solutions, can provide companies involved in the production and processing of flat metals with specialised expertise and turnkey solutions to help optimise their processes and increase their profitability.

Their global presence, spare parts supply and consultancy services enable them to work with local representatives and subsidiaries to provide customised solutions that meet local requirements and ensure successful implementation.

Or to make a long story short: EMG speaks the same language as the customer, both technically and verbally.

## EMG's Service Team: We Speak Your Language



Figure 14: With EMG experts you are not alone!

Perfecting your performance -  
That's our mission!

## Let's Start a Project with EMG!

We hope that you identified interesting themes and topics for own project ideas by reading this white paper. Of course, the next step is to start a more detailed discussion of your goals and your specific situation and maybe problems at the production line you have in mind.

» **1. Step: Getting into contact**

The best way to contact the EMG sales and service expert is a call to your local EMG representative. We have subsidiaries and representatives in all major metal producer and processor countries worldwide. In case you are not already in contact with your personal EMG partner, please visit our website at: <https://www.emg.elexis.group/en/contact#weltweit>

» **2. Step: On-site visit and basic technical clarification**

For all complex system solutions an on-site visit of one of our experts is indispensable.

The personal assessment of the plant situation and the installation options for the desired system allows a quotation tailored to the specific situation. Technical services such as feasibility studies or 3D laser measurements can also be part of the tasks here.

» **3. Step: Getting a quotation**

Following this important step our sales department is able to provide a tailored quotation, which forms the basis for further refinements and finally the contract negotiations.

» **4. Step: After contracting**

Once the contract has been signed, the typical steps of a technology project begin, from final technical clarification to system assembly in the EMG workshop, factory acceptance testing, installation supervision, interface implementation, and final acceptance, to name just a few.

» **5. Step: After sales**

After the system is in production use, you are not alone. EMG is offering all required remote and field services as well as spare part delivery and consultancy services. More about the spectrum of EMG services as well as hotline and contact links you'll find under:

<https://www.emg.elexis.group/en/service>

Finally, we would like to thank you for your interest and invite you to visit our headquarters in Wenden, Germany. We are sure that you will enjoy the atmosphere of a technology-driven, innovative, yet people-oriented, friendly company that strives for customer success and long-term partnerships!

Your  
Team EMG

## Contact Us!

For further information or if you would like to meet one of our experts, please contact us at any time!

Deru Bi, Head of Sales International  
Phone: +49 2762 612-303  
[deru.bi@emg-automation.com](mailto:deru.bi@emg-automation.com)

Jochen Fryn, Head of Sales Europe  
Phone: +49 2762 612-212  
[jochen.fryn@emg-automation.com](mailto:jochen.fryn@emg-automation.com)

[back to content](#)

**EMG**

an **eLEXIS** company

EMG Automation GmbH  
Industriestraße 1  
57482 Wenden  
Germany

T +49 2762 612-0  
[www.emg.elexis.group](http://www.emg.elexis.group)  
[info@emg-automation.com](mailto:info@emg-automation.com)